



## Adopting BIM at Design Phase for Structural Buildings

Assala S. Hadi<sup>1,\*</sup>, Abbas M. Abd<sup>2</sup>, Mohammed Mahmood<sup>1</sup>

<sup>1</sup>Department of Civil Engineering, University of Diyala, 32001 Diyala, Iraq

<sup>2</sup>Department of Transportation's Engineering, University of Diyala, 32001 Diyala, Iraq

### ARTICLE INFO

#### Article history:

Received 31 March 2021

Accepted 21 July 2021

#### Keywords:

BIM; Design phase; Revit; Robot; Etabs

### ABSTRACT

In the construction industry, using of traditional methods to design and perform the works with participation of different disciplines by individual method make the design of structure more pruched to errors and mistakes and increase the possibility of generate the wastes due to need sometimes to re- work. In addition to the continuous change of designs, and this needed to updating documents and plans manually to keep pace with these changes, thus wasting time and effort, so this considers "inefficient" practice. Building Information Modeling (BIM) is an innovative technology that makes the design phase and construction industry more efficient to achieve the requirements of sustainability. A case study was taken to investigate the possibility of using BIM technology and structural analysis softwares (Robot and Etabs) in the structural design stage, where a model is modeled in the Revit software, and it is exported to Robot and Etabs softwares for the purpose of analysis and design, which showed close design results between these design softwares with a slight difference in the amount of rebar, about 4% more by using the Etabs software for all the structure. All the process performed from modelling to analysis and design then extracting schemas and quantity estimation for reinforcement and concrete was done in a short time and with satisfactory results.

## 1. Introduction

The developments of BIM (Building Information Modeling) for the architecture, engineering and construction (AEC) industry have facilitated accurate modeling of structures, upgrading 2D drawing to 3D models, and significantly shortening the building life cycle for the building, particularly in the phases of drawing, modeling, analyzing, designing and detailing. BIM models richly describe building through classes of objects that contain their 3D geometry and other characteristics [1].

Information and communication technologies (ICT) are now widely utilized in the construction industries for decision-making in design and construction, such as Buildings Information Modelling (BIM) [2].

BIM is a modern and creative technology that has emerged in recent years and allows for more effective creation of more sustainable designs [3]. BIM is currently the most popular term for a new approach to building design, construction, and maintenance [4].

The fundamental knowledge for structural engineers can be found in structural BIM, which is a subset of BIM. Geometry, material properties, sectional properties, loads, load combinations, boundary conditions, and so on are all factors to consider. For structural analysis, as well as the generation of drawings and documents, structural BIM can be used [5]. One of the most important BIM advantages for structural engineers is improved productivity, data coordination, and consistency, as well as better visualization and simulation of situations

\* Corresponding author.

E-mail address: [eng.assala@gmail.com](mailto:eng.assala@gmail.com)

DOI: 10.24237/djes.2021.14303

and problems. Because of its ability to design, visualize, simulate, analyze, and record projects, BIM enables structural engineers to create projects with high performance, precision, and competitiveness [6]. Additionally, using BIM technology eliminates mistakes during design and drafting, lowering design and drafting costs as a result of increased efficiency.

Due to BIM's ability to promote collaborations among many disciplines, its use in the design and construction industry has increased in recent years. BIM can be used to speed up the extraction of information gathered from a variety of simulations, which can then be used to establish product creation criteria and recommendations. Essentially, this means that the BIM model can be used to produce a variety of effective solutions in the modeling of a project [7].

BIM is widely used as an advanced digital tool in the life cycle of a project to visualize, plan, communicate and work together between project- building and to promote efficient building data processes, accumulation, control, transformation, and delivery of construction data [8]. To visualize the whole life cycle of the construction process involving planning, design, construction, and operation, BIM can create a computer-based 3D model [9].

The off-site construction method is recommended for realizing the benefits of the proposed BIM-based approach. This is because the "perfect" installation plan necessitates specialized construction techniques, such as those used in off-site construction, which provide greater productivity and accuracy in the installation plan's practical execution. In other words, BIM provides a virtual and computational environment in which construction professionals can assess various construction plans prior to construction, while off-site construction allows professionals to complete actual construction activities in an organized and efficient manner within a user-friendly and tightly controlled factory environment. When BIM and off-site construction are used together, the benefits of each are maximized in terms of increased sustainability in the form of decreased construction waste [10].

This paper focuses on the ability to use BIM technology at the design phase and generate documents at the early stage of the project and obtaining on the sustainable practice design stage. A multi-story reinforced concrete building with three floors was used as a case study. Revit was used to model its structural components, which included material properties and section properties. The building model was exported from Revit to Robot and Etabs using BIM interoperability with Robot Structural Analysis and Etabs. The results of both software's analysis and design were compared.

## 2. Literature review

Sampaio, A. Z., & Azevedo, V. (2018) [11]: This research aims to comparative analysis between the traditional process and BIM methodology in the structural design stage and evaluate the advantages of adoption and use BIM methodology relatively to the procedure presents in the AEC industry.

Tsay, R. J. (2018) [12]: In this paper the researcher applied BIM software represent by Revit to build a structural model including geometry and reinforcement in RC system and then convert it into Etabs analysis software and obtain regional structure behavior and explore real structural security.

## 3. BIM at design phase

The BIM can assist at various levels in various stages of project life cycle such as design phase [13]. Design phase include three main phases:

- a) Schematic Design (SD): Making 3D models and simulations to achieve more effective, the sustainable and a zone of the product different possible solutions that is similar.
- b) Detailed Design (DD): The study of the structure and building.
- c) Construction Detailing (CD): Shop drawings and planning schemes, intervention detection through various fields (e.g., design of structural and architectural with the disposal of the installations).

In design phase, the direct and immediate consequences by using BIM are reducing the time, increase the quality and this led to decrease of the enterprise total cost [14]. Some of other benefits to use BIM in design stage are concepts becomes clearer and project conceptualization easier, earlier and more accurate visualizations of a design to the owner, support decision making regarding the design, improve simulations and coordination, improve mistake identification thus reducing conflict errors, improve lean in design, save design time and cost, risk reeducation and enhance accuracy of existing documentation [15].

In spite of all the features mentioned above but there are some obstacles to implementation BIM technology in building industry such as [16].

1. The building industry aversion to altering its conventional working practices.
2. Adaptation of emerging technology takes longer.
3. Lack of awareness of the BIM and sustainability systems and workflows.

#### 4. Case study

The simple structural building had been taken as a case study modelling at Revit. In an advanced BIM environment, Revit enables

structural engineers to build models and documentation. Engineers and detailers can build models to a higher degree of fidelity for Fabrication and Installation by using Revit structural designers and engineers can create accurate design intent models and offer engineers and detailers the knowledge they need [17].

The case study that shown in fig (1) consists of four floors, the first three floors have the same area 200 m<sup>2</sup>, the height of each floor 3m, begins from ground level at 0 m end to the third level at 12 m. The structural building content of (31) columns and (40) beams have the same rectangular sections (0.5×0.5m) and floors with 0.2m thickness. Understanding the idea of geometric and analytical representations of structure is important before modeling [17]. The geometrical model is the true model that contains all details, and it is what users modeled inside Revit and is used for communication and documentation, while the analytical model is modeled automatically in the context of the geometrical model inside Revit and transfers only the information that the structural engineer needs. The structural analysis software deals with the analytical model. It's used in structural analysis and design to quickly incorporate structural loads, load combinations, and boundary conditions.

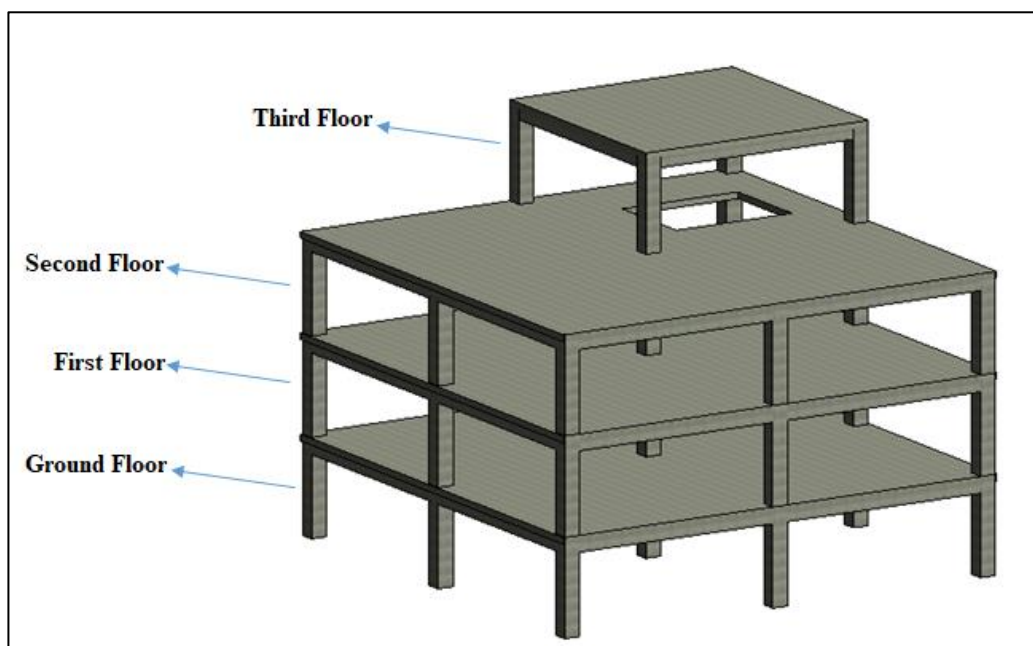

Figure 1. Modeling geometrical case study at Revit

Apply two types of load dead load and live load at analytical model as Fig (2). Dead load applied as area load (3 KN/m<sup>2</sup>) spread on the slabs to all levels, and line load (2 KN/m) placed

on the edge of slabs to levels from 2 to 4. Live load (3 KN/m<sup>2</sup>) as area load spread on slabs for levels from 2 to 4.

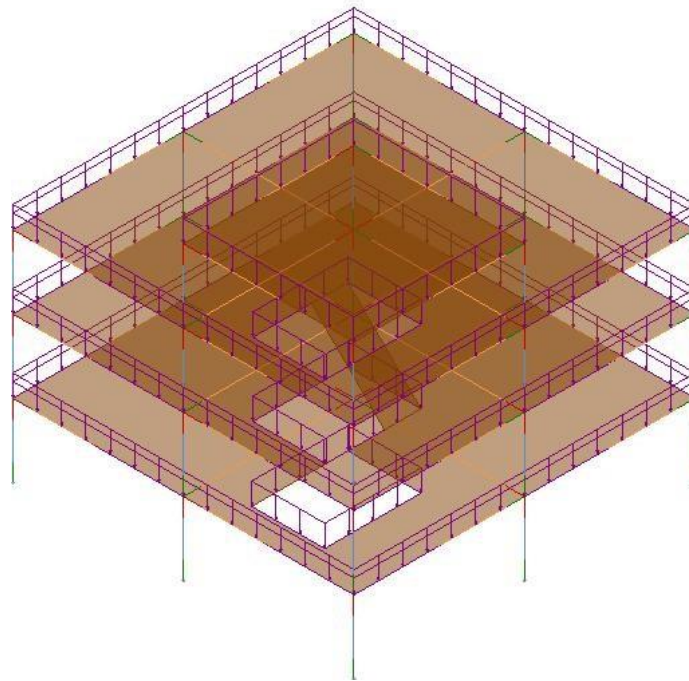

Figure 2. Applying loads

Two simple cases of load combinations applied were serviceability and ultimate as Fig (3).

Serviceability = 1(dead load +live load).  
 Ultimate = 1.2×dead load + 1.6× live load.

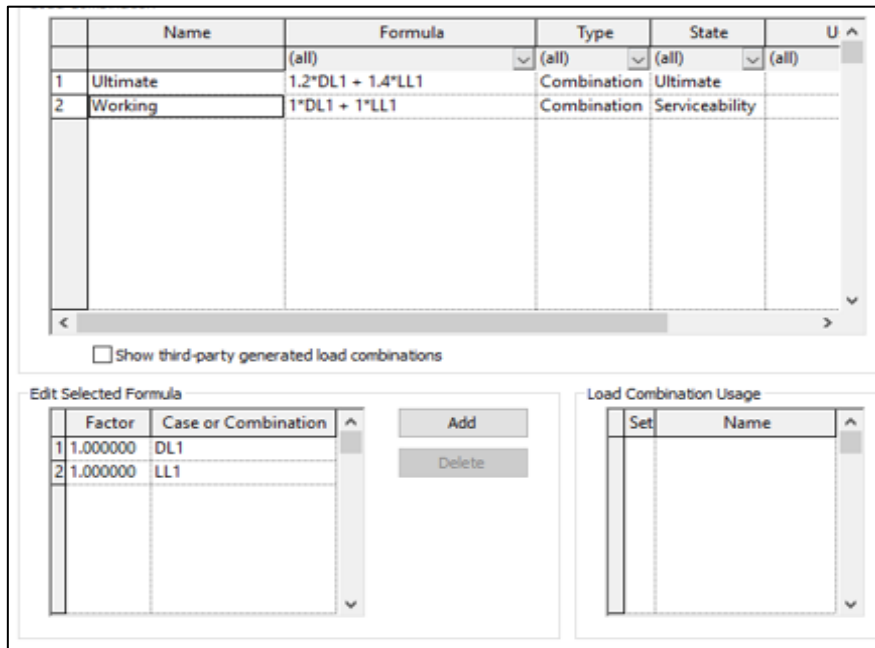
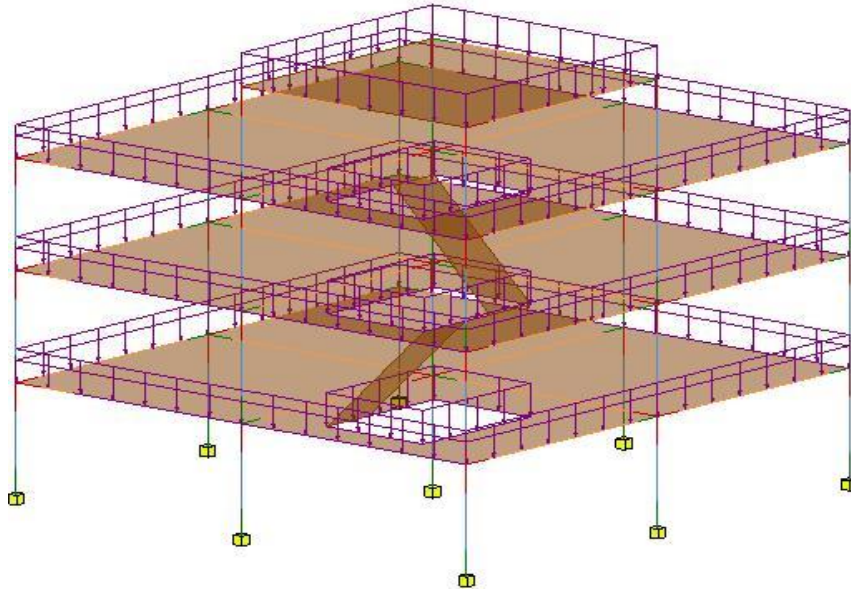

Figure 3. Applying load combinations

Boundary conditions applied as point fix support on the base of columns at ground level for the analytical model as presented in Fig (4).



**Figure 4.** Applying boundary conditions

After completing all steps above and finishing modeling at Revit, the model export to Robot and Etabs for structural analysis and design. The export process is done between Revit and Robot by the direct link between this software as shown in Fig (5) where appear the

exported model at Robot. As shown in Fig (6), the integration process is carried out between Revit and Etabs using the CSIXRevit tool. The CSIXRevit tool is an Autodesk Revit plugin that enables bi-directional data exchange with CSI software as an EXR file [18].

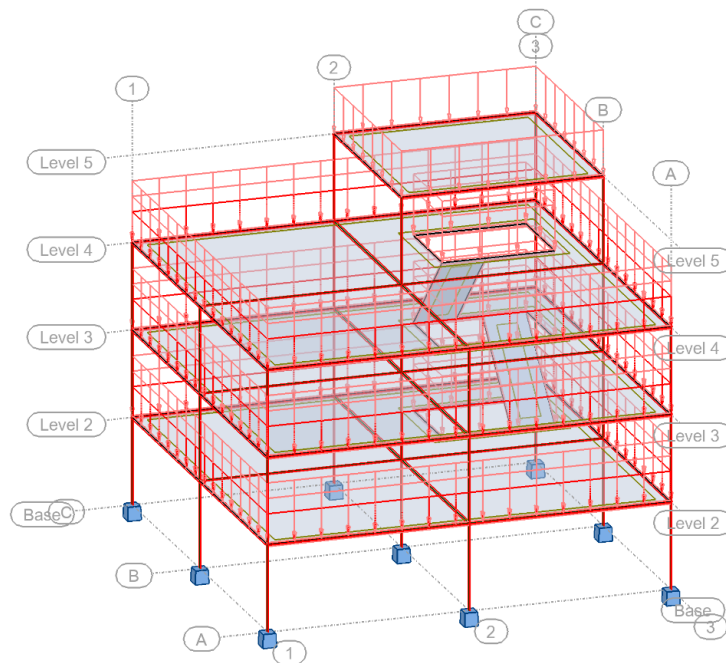

**Figure 5.** Export model to robot

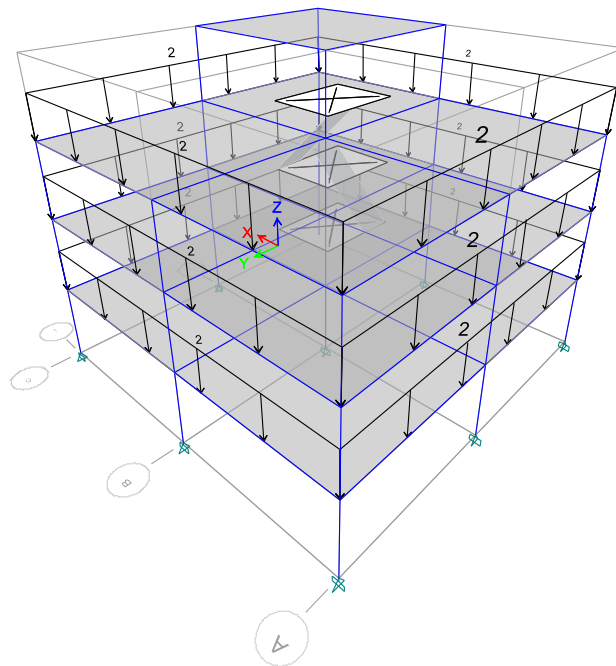

**Figure 6.** Export model to Etabs

When Revit model transfer completely to structural analysis softwares, mesh options are set and then run analysis at both softwares at

Robot as shown in Fig (7) and at Etabs as Fig (8) where contains the analysis model.



**Figure 7.** Analysis model at Robot

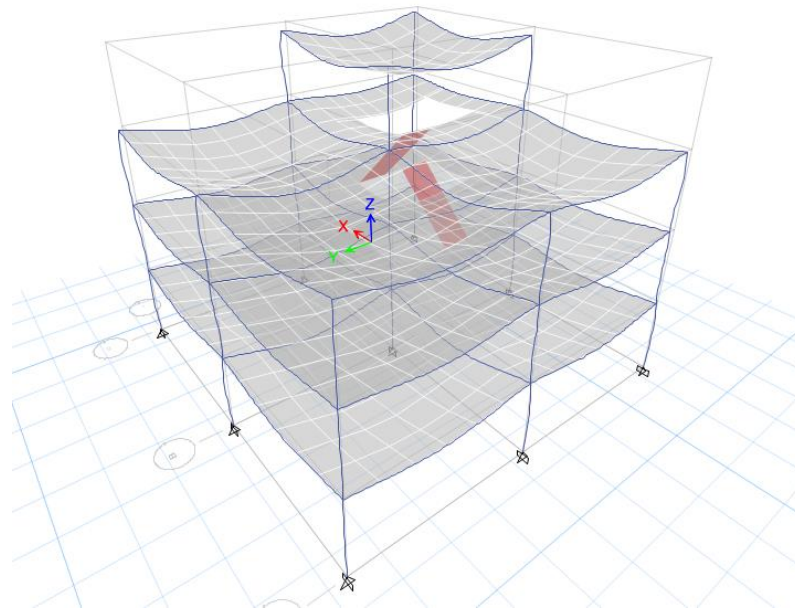

**Figure 8.** Analysis model at Etabs

**5. Result and discussion**

After completing the analysis, the design process for all structural elements (columns, beams, and slabs) is initiated by selecting the structural element and then selecting the design command to provide the steel area needed with reinforcement detailing (bar diameter, number, and spacing between bars) and a perfect structural drawing at Robot. The design command in Etabs, on the other hand, was used

to create the design. It specifies the reinforcement area for all frames and slabs in the construction, as well as the reinforcement specifics for columns and beams. Figures 9 to 14 display the design production for various structural components.

As shown in Figures (9 and 10) the rebar of columns and beams distribution in 3D shape with their diameter, number and spacing between them at Robot.

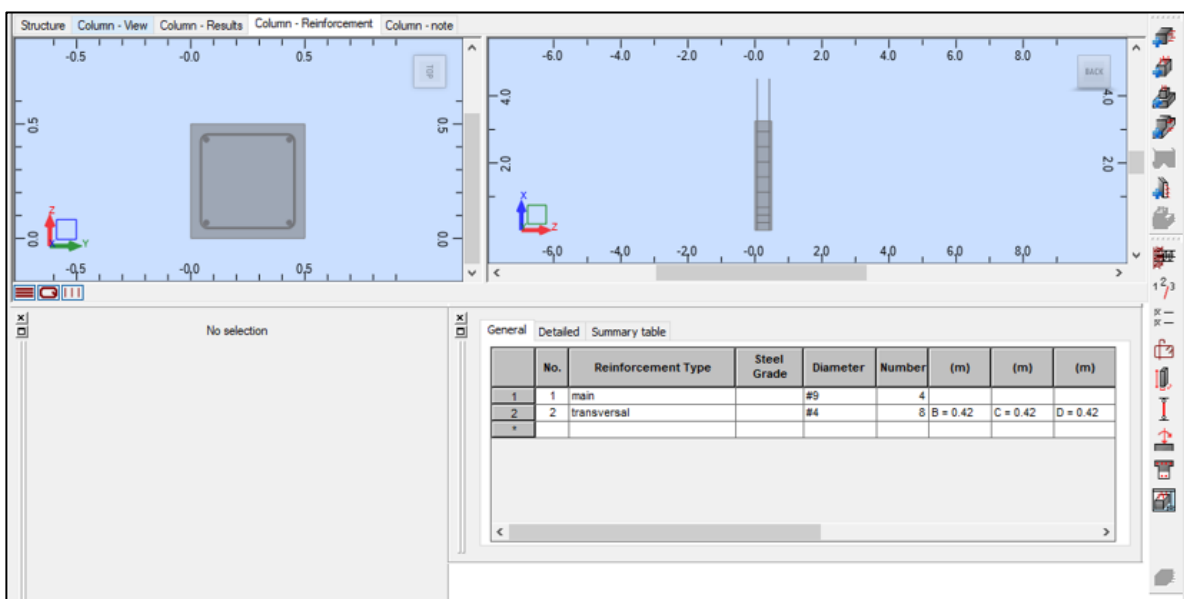

**Figure 9.** Design of columns at Robot

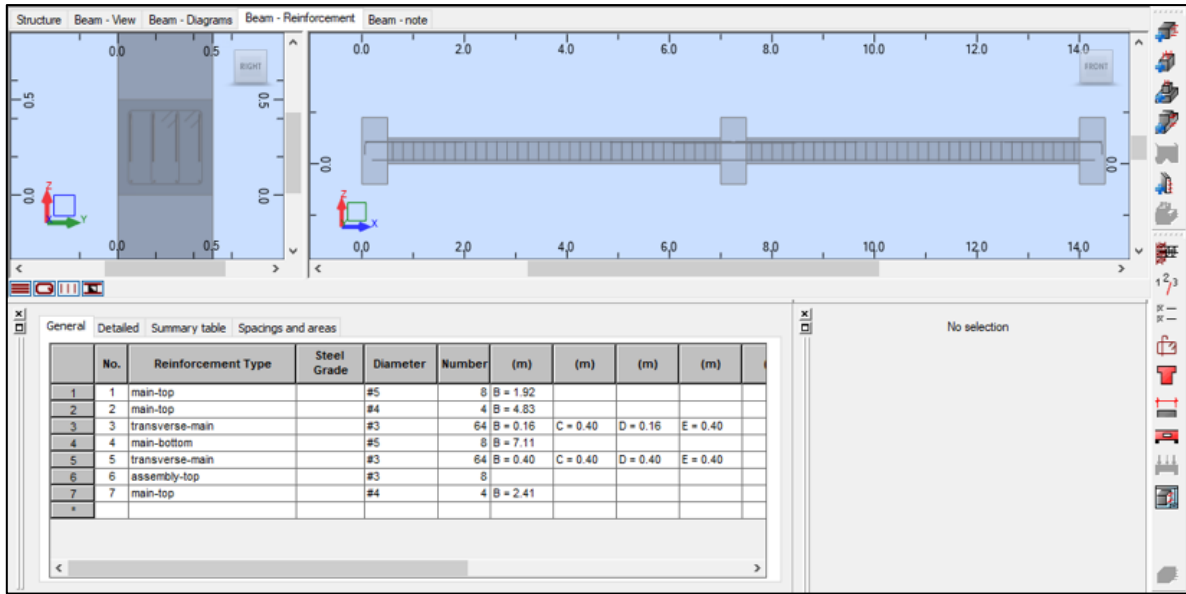

Figure 10. Design of beams at Robot

Figure (11) show the reinforcement area required for each column and beam in the structure designed at Etabs.

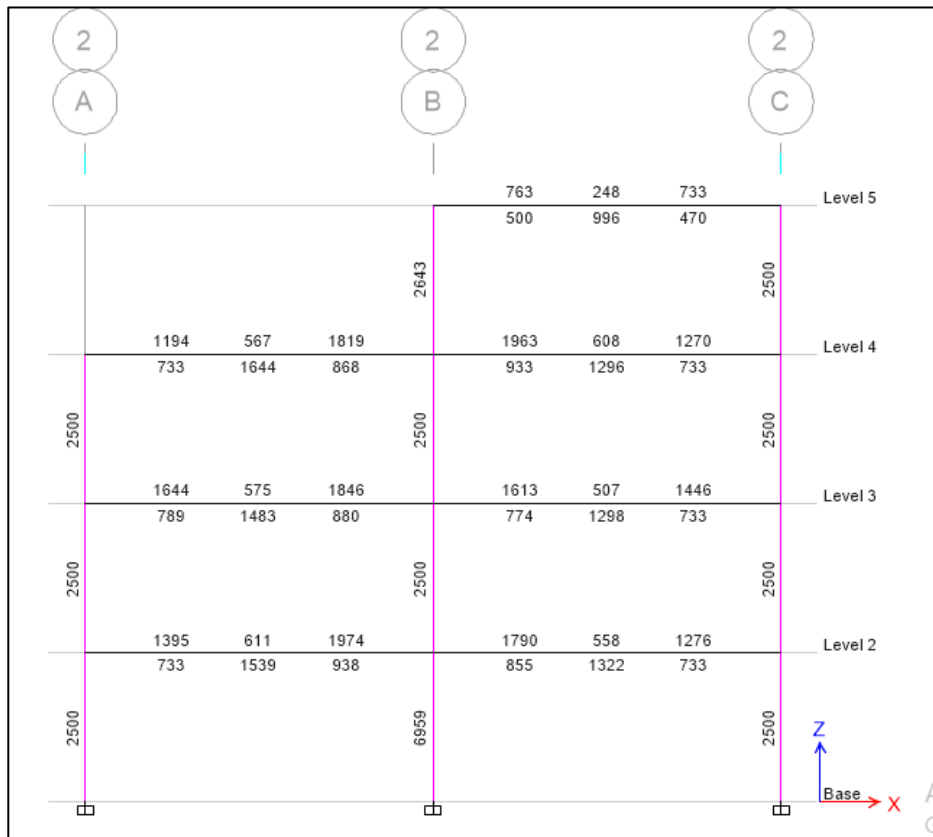

Figure 11. Design of columns and beams at Etabs



Figure (12) show the detailing of rebars diameter, number and spacing between them for each column at each level at Etabs.

**Concrete Column Schedule**

	CC1			CC2			CC3			CC4		
	COLUMN SIZE	SECTION	REINFORCING	TIES ZONE-A	TIES ZONE-B	TIES ZONE-C	COLUMN SIZE	SECTION	REINFORCING	TIES ZONE-A	TIES ZONE-B	TIES ZONE-C
Level 5												
Level 4												
Level 3			8-20 (2,500.00)						8-20 (2,500.00)			
Level 2	600 MM X 500 MM	A	10@100 MM	10@100 MM	10@100 MM	600 MM X 500 MM	A	10@100 MM	10@100 MM	10@100 MM	600 MM X 500 MM	A
Base			8-20 (2,500.00)						16-26 (6,956.81)			

Figure 12. Reinforcement details of columns and beams at Etabs

Figure (13) show the designed slab at Robot which each color refers to the reinforcement

needed at this area with its diameter, number and spacing between rebar.

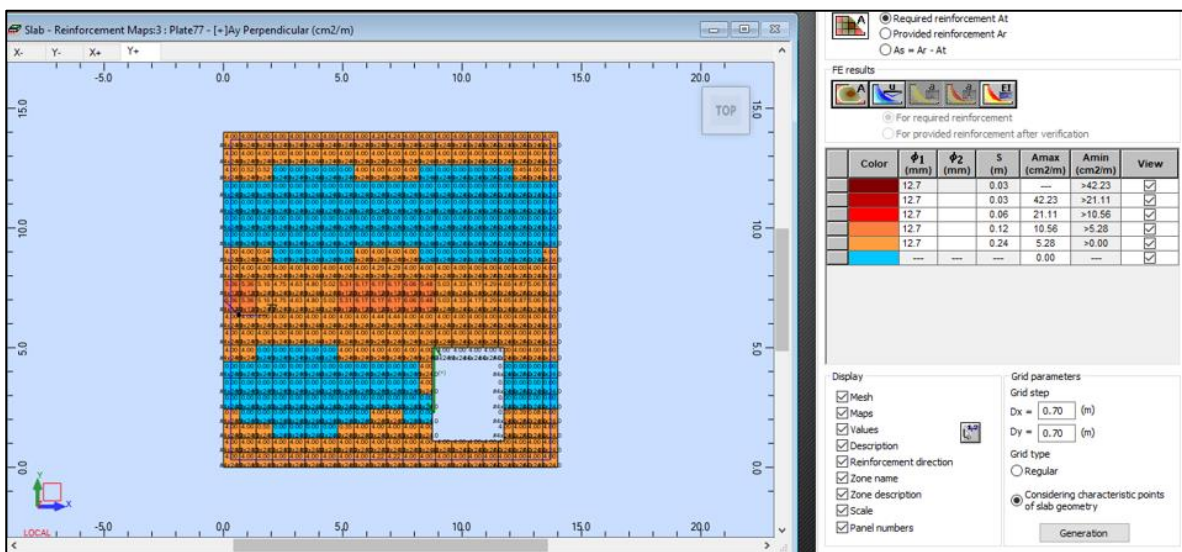

Figure 13. Design of slabs at Robot

At the same, slab designed at Etabs as shown in figure (14) which also each color refer to the reinforcement needed at this region and present the box of slab design to select the

method of design (finite element based or strib method) and the reinforcement needed in each direction with diameters of rebar and spacing between them.

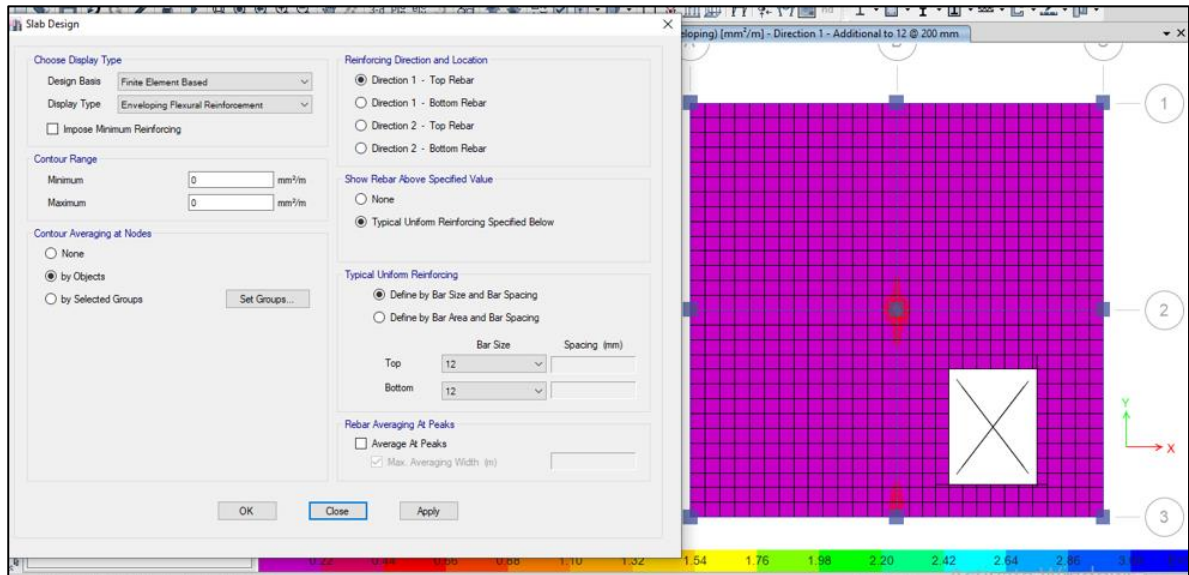

Figure 14. Design of slabs at Etabs

After completing the design process, the Revit model is updated from Robot, where the direct link between Revit and Robot provides

the ability to transfer reinforcement designed at Robot for columns and beams to Revit as shown in Fig (15).

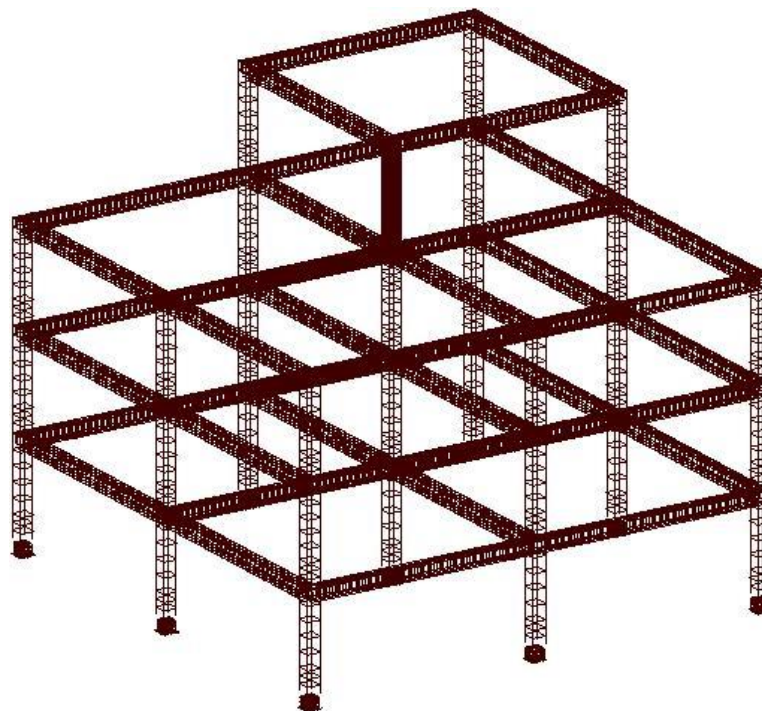
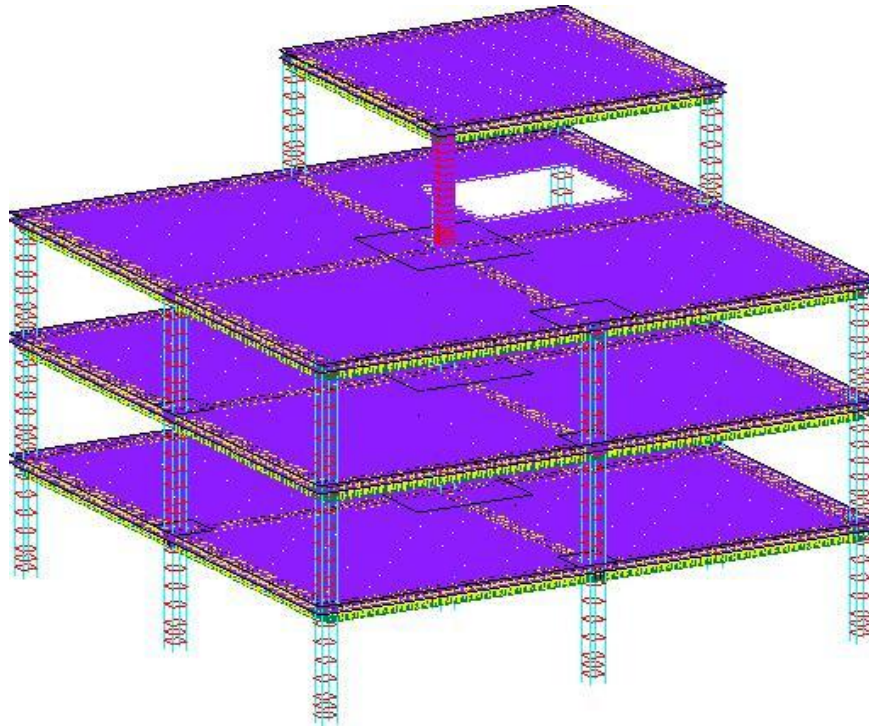

Figure 15. Update Revit model from Robot

Within Revit, modelling reinforcement based on Etabs design results necessitates using the Naviate Rebar Extension tool (Naviate REX) to draw reinforcement of columns and

beams, as well as the Rebar tool that is available inside Revit to draw reinforcement of slabs based on their design at Robot and Etabs, as shown in Fig (16 and 17).



**Figure 16.** Modelling reinforcement at Revit according to its design at Robot

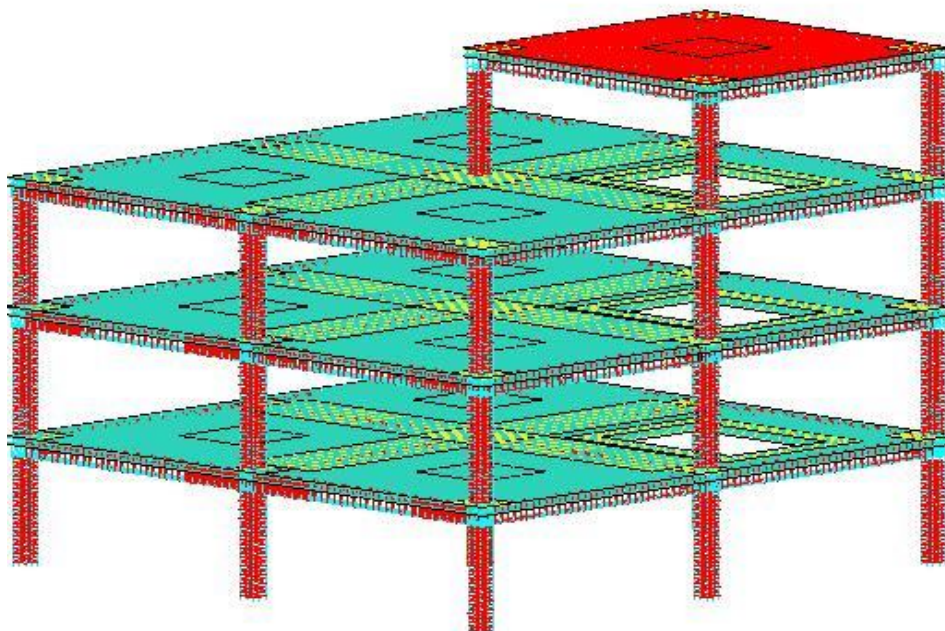

**Figure 17.** Modelling reinforcement at Revit according to its design at Etabs

Finally, as shown in Fig (18), extract schedules of Rebar and concrete amounts that were determined automatically in Revit.

<Rebar schedule of simple structure designing at Robot>				
A	B	C	D	E
Type	Bar Diameter	Bar Length	Total Bar Length	Reinforcement Volume
#3-Grade 40				
#3-Grade 40	10 mm		5877.760 m	0.419 m <sup>3</sup>
#3-Grade 40: 162			5877.760 m	0.419 m <sup>3</sup>
#3-Grade 60				
#3-Grade 60	10 mm		1751.960 m	0.125 m <sup>3</sup>
#3-Grade 60: 244			1751.960 m	0.125 m <sup>3</sup>
#4-Grade 40				
#4-Grade 40	13 mm		940.290 m	0.119 m <sup>3</sup>
#4-Grade 40: 69			940.290 m	0.119 m <sup>3</sup>
#4-Grade 60				
#4-Grade 60	13 mm		13017.220 m	1.649 m <sup>3</sup>
#4-Grade 60: 507			13017.220 m	1.649 m <sup>3</sup>
#5-Grade 60				
#5-Grade 60	16 mm		1936.960 m	0.383 m <sup>3</sup>
#5-Grade 60: 408			1936.960 m	0.383 m <sup>3</sup>
#6-Grade 60				
#6-Grade 60	19 mm		43.880 m	0.013 m <sup>3</sup>
#6-Grade 60: 20			43.880 m	0.013 m <sup>3</sup>
#9-Grade 60				
#9-Grade 60	29 mm		472.800 m	0.305 m <sup>3</sup>
#9-Grade 60: 120			472.800 m	0.305 m <sup>3</sup>
Grand total: 1530			24040.870 m	3.012 m <sup>3</sup>

Figure 18. Extract quantities of reinforcement and concrete at Revit

Total reinforcement quantities of columns designed by Robot is (0.434 m<sup>3</sup>) and that design by Etabs is (0.467 m<sup>3</sup>). The percentage difference in reinforcement quantities of columns between Robot and Etabs is found about (-7%), where reinforcement quantity at Robot is less by about 7% than Etabs. And the concrete quantity of columns is 21.72 m<sup>3</sup>.

Total reinforcement quantities of beam designed by Robot is (1.095 m<sup>3</sup>) and that designed by Etabs is (1.140 m<sup>3</sup>). The percentage of difference in reinforcement quantities of

beams between Robot and Etabs is found about (-4%), where reinforcement quantity at Robot is less by about 4% than Etabs. And concrete quantity of beams is 39.19 m<sup>3</sup>.

Total reinforcement quantities of floors designed by Robot is (1.483 m<sup>3</sup>) and that designed by Etabs is (1.533 m<sup>3</sup>). The percentage the difference in reinforcement quantities of floors between Robot and Etabs is found about (-3%), where reinforcement quantity at Robot is less by about 3% than Etabs. And concrete quantity of slabs is 131.04 m<sup>3</sup>.

Table 1: Quantities of structural elements design by BIM

Structural elements	Sections (m)	Count	Concrete Quantities(m <sup>3</sup> )	Reinforcement Quantities (m <sup>3</sup> )	
				Robot	Etabs
Columns	0.5*0.5	31	21.72	0.434	0.467
Beams	0.5*0.5	40	39.19	1.095	1.140
Slabs	0.2	4	131.04	1.483	1.533
<b>Total</b>			191.95	3.012	3.140

## 6. Conclusions

Compared to traditional methods used in the construction industry, the use of BIM methodology facilitates the process of obtaining

results, whether results of analysis, design, or quantity estimations. Where the processes that require the participation of several disciplines to perform it and takes a lot of time can be performed easily by using BIM and in a short time. The use of BIM technology provides the ability to create documents through the early phases of the project and along with project life's, these documents automatically update with any change in the BIM model.

This study proves the possibility of using BIM technology to work on a single model that is used for analysis and design through more than one structural software and to obtain structural design results with rebar distribution diagrams within a short time in addition to the ability to estimate quantities at Revit. For case study appear small difference in the percentage of reinforcement between Robot and Etabs about -4% for all the structure, where the quantity of reinforcement designed at Robot less than that designed at Etabs. Therefore, despite the type of analysis software used (which is return to the preferences of the engineer), the use of BIM technology in the structural design stage is effective.

## References

- [1] Hasan, A. M., Torkey, A. A. & Rashed, Y. F. (2019). Geometrically accurate structural analysis models in BIM-center software. *Automation in Construction*, 104, 299-321.
- [2] Inyim, P., Rivera, J., & Zhu, Y. (2015). Integration of building information modeling and economic and environmental impact analysis to support sustainable building design. *Journal of Management in Engineering*, 31(1), A4014002.
- [3] Wong, K. D., & Fan, Q. (2013). Building information modelling (BIM) for sustainable building design. *Facilities*, 31(3/4), 138-157.
- [4] Abanda, F. H., & Byers, L. (2016). An investigation of the impact of building orientation on energy consumption in a domestic building using emerging BIM (Building Information Modelling). *Energy*, 97, 517-527.
- [5] Robinson, C. (2007). Structural BIM: discussion, case studies and latest developments. *The structural design of tall and special buildings*, 16(4), 519-533.
- [6] Hunt, C. A. (2013). The benefits of using building information modeling in structural engineering.
- [7] Bynum, P., Issa, R. R., & Olbina, S. (2013). Building information modeling in support of sustainable design and construction. *Journal of Construction Engineering and Management*, 139(1), 24-34.
- [8] Hammond, R., Nawari, N. O., & Walters, B. (2014). BIM in sustainable design: strategies for retrofitting/renovation. In *Computing in Civil and Building Engineering (2014)* (pp. 1969-1977).
- [9] Zhang, L., Chu, Z., & Song, H. (2020). Understanding the relation between BIM application behavior and sustainable construction: A case study in China. *Sustainability*, 12(1), 306.
- [10] Liu, H., Sydora, C., Altaf, M. S., Han, S., & Al-Husseini, M. (2019). Towards sustainable construction: BIM-enabled design and planning of roof sheathing installation for prefabricated buildings. *Journal of Cleaner Production*, 235, 1189-1201.
- [11] Sampai, A. Z., & Azevedo, V. (2018). Structural Design Developed in a BIM Environment: Benefits and Limitations.
- [12] Tsay, R. J. (2019, February). A Study of BIM Combined with ETABS in Reinforced Concrete Structure Analysis. In *IOP Conference Series: Earth and Environmental Science (Vol. 233, No. 2, p. 022024)*. IOP Publishing.
- [13] Azhar, S., Khalfan, M., & Maqsood, T. (2012). Building Information Modeling (BIM): now and beyond. *Construction Economics and Building*, 12(4), 15-28.
- [14] Azevedo, V. (2014). BIM model analysis in the structural design perspective. *Instituto Superior Técnico-Universidade de Lisboa, Av. Rovisco Pais, 1, 1049-001*.
- [15] Ibrahim, H. S., Hashim, N., & Jamal, K. A. A. (2019, November). The Potential Benefits of Building Information Modelling (BIM) in Construction Industry. In *IOP Conference Series: Earth and Environmental Science (Vol. 385, No. 1, p. 012047)*. IOP Publishing.
- [16] Olawumi, T. O., Chan, D. W., Wong, J. K., & Chan, A. P. (2018). Barriers to the integration of BIM and sustainability practices in construction projects: A Delphi survey of international experts. *Journal of Building Engineering*, 20, 60-71.
- [17] Autodesk 2017 Revit for Structural Engineering Autodesk
- [18] Computers and Structures Inc. 2019 CSIXRevit CSIXRevit.